

Installation MANUAL

PACBRAKE[®]
ENGINE & EXHAUST BRAKES



P-80 And P-80A **ENGINE BRAKE**

P-80 application:

**Detroit diesel engines - 2000 model year
12.7/14 Liter Series 60**

P-80A application:

**Detroit diesel engines - 2001/2002 model year
12.7/14 Liter Series 60**

VERY IMPORTANT APPLICATION INFORMATION

Please read carefully as incorrect application will cause engine damage.

1 Before Starting

Use the following information to determine the correct Pacbrake for your application.

Engine Year	Identification Characteristic	Pacbrake Model
1999	Roller for master piston on injector rocker arm	P-63C
2000	Pocket for master piston on injector rocker arm 81.0 mm injector setting	P-80
2001	Pocket for master piston on injector rocker arm 82.1 mm injector setting	P-80A

Check the engine serial number and engine build date PRIOR to installing this Pacbrake engine brake.

P-63C model fits engines manufactured before 12/15/99

P-63C model fits Freightliner engines below 06R566178

P-63C model fits OEM engines below 06R566302

P-80 model fits engines manufactured 12/15/99 to 8/10/00

P-80 model fits Freightliner engines above 06R566178

P-80 model fits OEM engines above 06R566302

P-80A model fits engines manufactured 8/10/00 to 9/30/02

P-80A model fits engines with 82.1mm injector lash

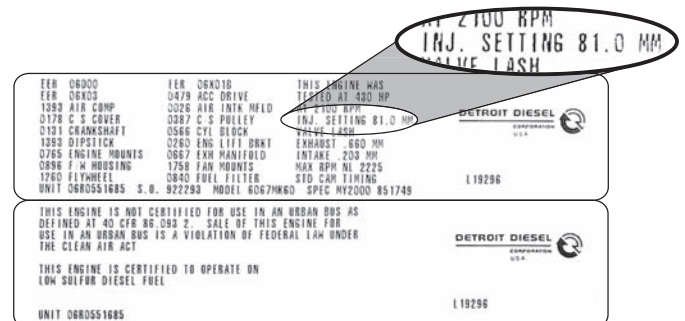

These new 2000 model year engines are built starting late December 1999 and differ from the 1999 model year engine by the elimination of the engine brake's dedicated roller on the injector rocker arm. The 2000 model year engine has a machined pocket in the injector rocker arm to replace the roller. Installing the incorrect engine brake will cause engine and engine brake failure.

Check the engine's option label on the valve cover for injector setting information. Injector settings relate to the engines camshaft. The only way to visually confirm which camshaft the engine has is by checking the injector setting on the options label. See above. Misapplication will cause engine damage. If unsure please contact Pacbrake Factory @ 1-800-663-0096.

DDEC III and DDEC IV Applications

Note: Two different engine brake activation circuits are available for Series 60 engines. The engine ECU has an optional circuit to control the engine brake. Use a Prolink diagnostic tool to determine if the circuit is turned on. If the circuit is not turned on for engine brake enable, it can be reprogrammed by a Detroit Diesel Dealer for a service charge. When using this activation circuit, if no under cover wiring exists, use Pacbrake Kit P80155.

An optional ECU bypass system P60154 is available through Pacbrake distribution. This system uses a foot switch and a service brake pressure switch to enable the engine brake, the engine ECU does not need to be reprogrammed for this system. P60154 kit includes all the necessary components for electrical installation.

2

Before starting, check that the kit contains everything shown in this photo.

CAUTION: Care should be taken when handling housing. Dropping housing could cause leg damage/failure which is not covered under warranty.

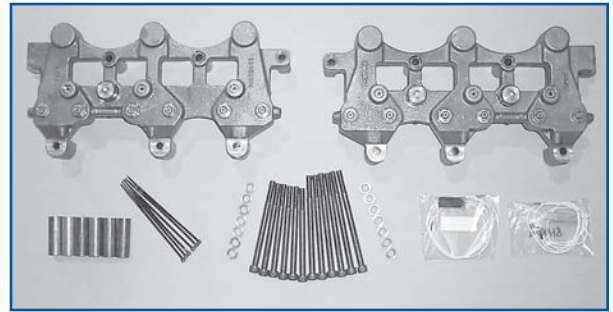

Tools Required

3/8 Drive ratchet	General use
1/2 Drive ratchet	General use
Inch/pound torque wrench	Valve cover bolts
3/8 Torque wrench accurate @ 25 lb. ft.	Paclash adjustment
1/2 Torque wrench accurate @ 100 lb. ft.	Hold down capscrews
Speeder handle	Housing capscrews & nuts
1/2 Breaker bar or flex bar	Rocker shaft capscrews removal
36mm Socket	Rotate engine
18mm Deep socket 1/2 drive	Rocker shaft capscrews
10mm Socket 3/8 drive	Valve cover capscrews
10mm Hex driver	Pacbrake housing capscrews
#1 Phillips screw driver	Solenoid terminal
5/32 (4mm) Allen wrench	Paclash adjustment
3/4" Box End wrench	Paclash adjustment
9/16" Box End wrench	Paclash adjustment
3/4" Crows foot	Torque paclash
3/8" Extension 3"	With crows foot
3/8" Extension 6"	Valve cover capscrews
3/16" Extension 6"	Valve cover capscrews
Flat blade screw driver	Breather tube hose clamp
Wire cutters	Tystraps
Compressed air/air nozzle or suitable device	Blowing out bolt holes
Threebond liquid gasket PN# 1217F	Valve cover sealant at bearing caps if required.

Additional tools for engines which are not factory wired:

13 mm Socket	Cylinder head wiring connector
Needle nose pliers	Removal of plugs in connector

3

Stamped on the side of the engine block is the engine serial number and model number. (Sample 6067MK60) The first letter in the engine model number indicates displacement. The second letter indicates the type of electronic control system. If unsure, attain the engine serial n



- 4** Thoroughly clean the top of the engine and remove the valve cover.

NOTE: The valve cover is installed with a silicone adhesive on both sides of the front and rear bearing caps. Take care not to stretch the gasket when removing the cover. (See page 3 for sealing material if required). If your engine is prewired, locate the three dedicated wires and omit the following steps 5 through 15.

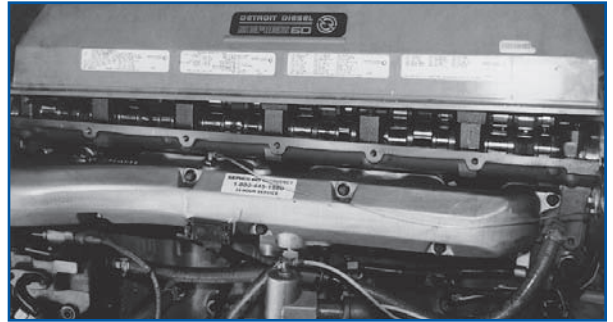

Engine Is Not Prewired

- 5** Remove the wiring harness mounting flange from the rear of the cylinder head.



- 6** There are four spare holes through the harness grommet which are sealed with plastic plugs. Pulling outward, remove any two of these plugs.



- 7** Insert both wires of the Pacbrake 'through head harness' through the grommet from the outside.

NOTE: In trucks with limited access at the rear of the cylinder head, it may be easier to slide the grommet out of the head.



8 Route the wires alongside the Electronic Unit Injector (EUI) harness and adjust the length so the terminal ends are between cylinders 5 and 6.



9 Lay the two wires in the convoluted conduit and replace the harness mounting flange.



10 Bury the wires within 1" of the Weather Pack connector and tape around the conduit to keep in place.

NOTE: By using this same connector and wire positions, the Pacbrake harnesses are completely compatible with the Detroit Diesel engine harness and the OEMs vehicle harness.

NOTE: If installing a P60154 kit, follow the instructions provided in the P60154 kit.



11 ENGINES WITH ENABLE CIRCUIT TURNED ON ONLY

Locate the red (561) and orange (562) wires terminating in the Metri-Pack plug. This is located in the harness on the drivers side of the engine just below the intake manifold, above the starter.

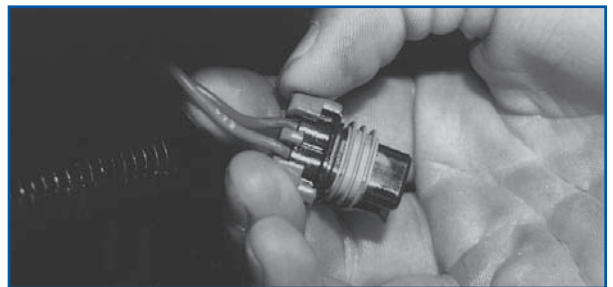

12 ENGINES WITH ENABLE CIRCUIT TURNED ON ONLY

Remove the black protective cap and connect to Pacbrake harness previously installed in step 7..



13 ALL INSTALLATIONS WITHOUT FACTORY WIRING

The through head harness must now be connected to the under cover harness, P/N P80048. As both halves of the connector are preassembled, simply insert the plain white wire into the hole on the same side as the other plain white wire. The remaining wires both have black shrink tube markings.

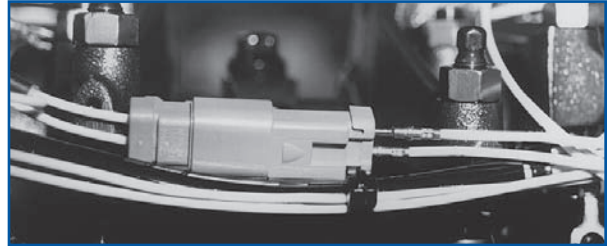

14 ALL INSTALLATIONS WITHOUT FACTORY WIRING

This connector is polarized and may now be parted and reconnected without losing correct brake sequencing.



15 ALL INSTALLATIONS

Secure the complete Pacbrake harness to the EUI harness with plastic ties.

Note: Use only the ties supplied in the kit which are temperature stabilized and will not deteriorate due to heat.

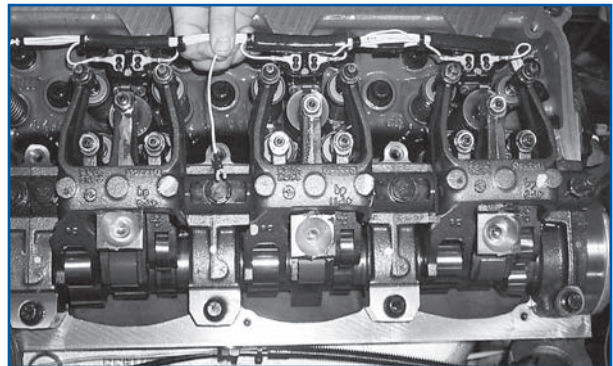

Brake Housing Installation

- 17** Evenly remove the three rocker shaft capscrews and nut for each rocker shaft assembly as shown in illustration — numbered 1,2, 3 and 4 then number 5, 6, 7 and 8. Discard the capscrews and save the nuts for reuse later.

NOTE: It is a recommended procedure to check the torque of the studs at #1 and #8 position. Once the nuts are removed, torque to 101-116 N·m (75-86 lbs. ft) as per DDC procedure.

CAUTION: Using air pressure or a suitable suction device remove trapped oil from mounting holes 2 through 7 and 9 through 14.

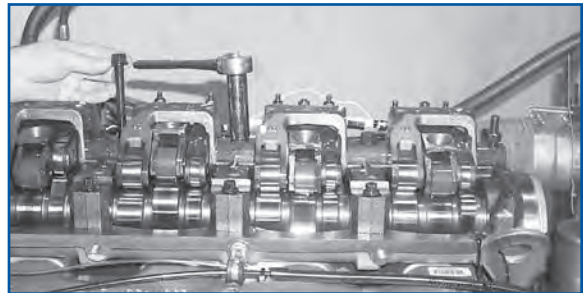
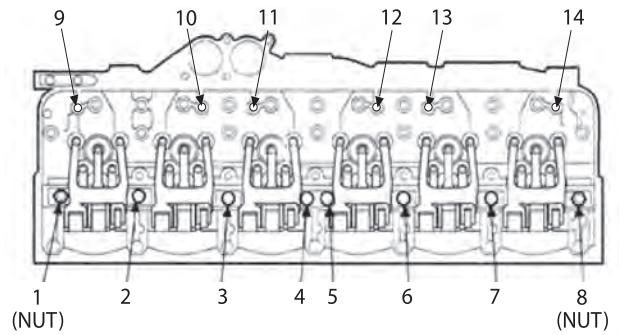

- 18** Place the 6 spacer tubes on the exhaust manifold side of the engine in locations 9 through 14 on previous diagram.

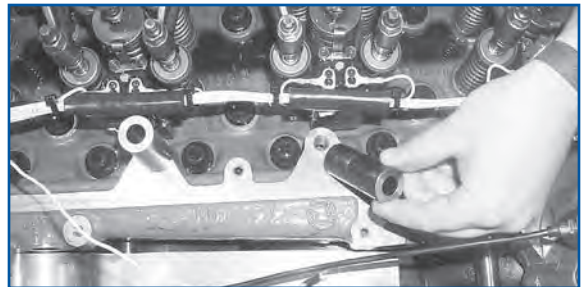

- 19** Place the special hardened washers on each of the 12 Pac-brake capscrews supplied.



19 Locate the 6 longer capscrews, these go through the center positions of the housing to secure the housing and rocker shaft. Lubricate and install three of these allen head capscrews through the center holes in each housing. Carefully position the front engine brake housing over cylinders 1, 2 and 3 using the front Detroit stud as a guide. Repeat on the rear housing using the rear stud as a guide.

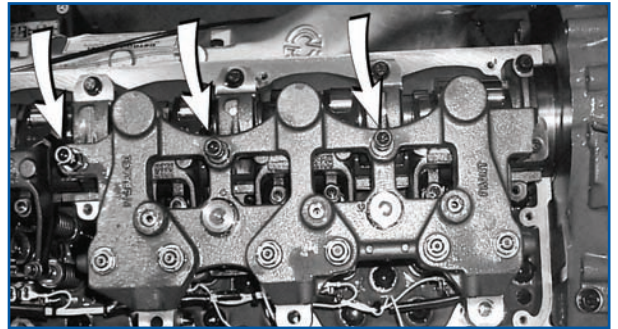

20 Install Pacbrake washers on the Detroit rocker studs then loosely install the two rocker hold-down nuts removed earlier.

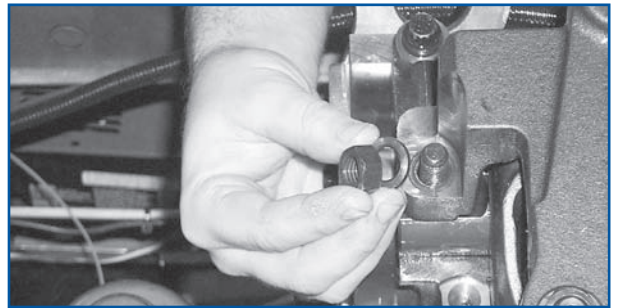

21 Loosely install the six shorter allen head capscrews on the turbocharger side of the Pacbrake housing.

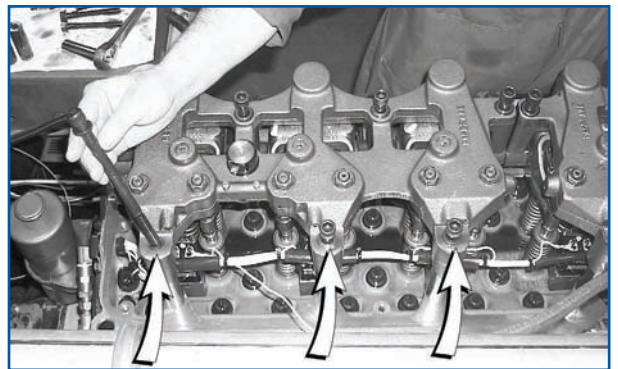
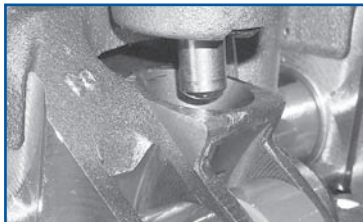

Note: Ensure that each master piston link is located over its rocker arm socket.

22 Carefully run the capscrews and nuts down evenly in the torque sequence below using hand tools only. Do not use an impact wrench as the housings must be tightened down evenly.

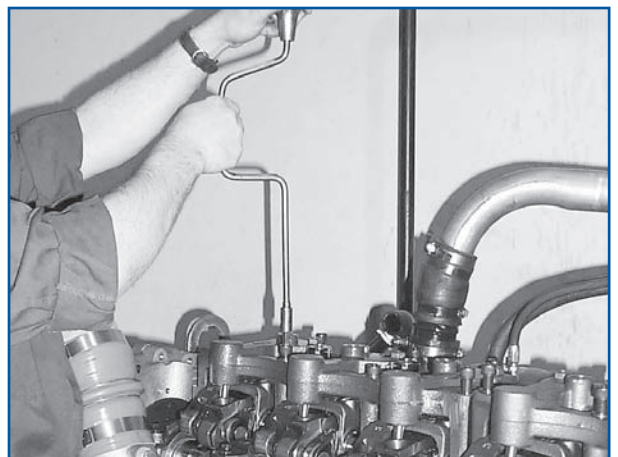

23

Torque the hold-down cap screws and nuts to 55 N•m (40 lb. ft.) in the sequence shown below. Then to 136 N•m (100 lb. ft.). Double check all bolt torques.

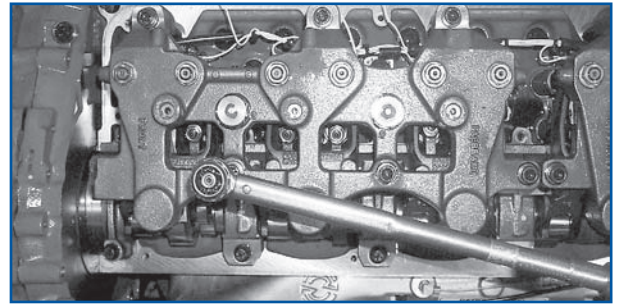
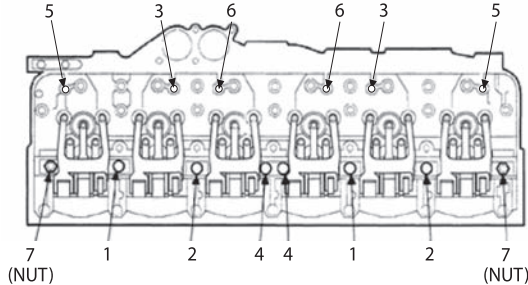

24

Attach the three wires to the solenoids. Using the plastic ties provided secure the harness away from all moving parts. Wires may be tied to spacer tubes. Use only the ties provided as they are temperature stabilized and will not deteriorate due to heat.

CAUTION: Route wires on front housing as shown by arrow.

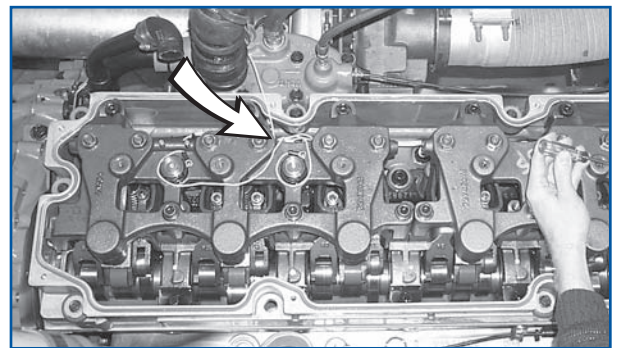

25

Slave Piston Adjustment

Loosen all twelve slave piston adjusting screws and lock-nuts. Determine which cylinders have clearance between exhaust rocker arm adjusting screws and valve stems, indicating that the exhaust valves are fully closed. There are usually four cylinders in this condition regardless of the crankshaft position.

NOTE: Both screws on each cylinder having closed valves may be adjusted.

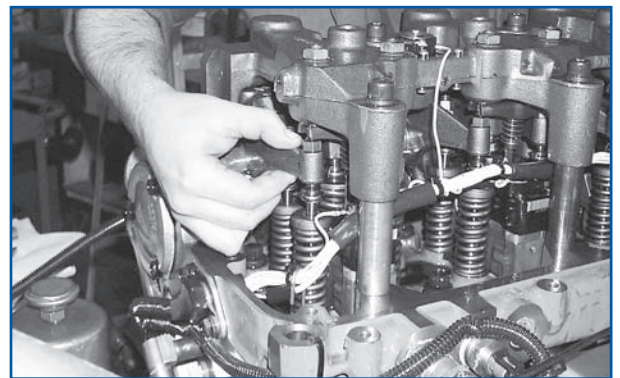

26

Slave lash may now be adjusted on all cylinders which have clearance between the exhaust rocker adjusting screw and valve stems. Turn the slave adjusting screw clockwise to establish zero exhaust valve lash. Once zero lash is determined, turn screw an additional 1/4 turn to squeeze out any trapped oil, then back screw out to zero exhaust valve lash.

IMPORTANT!

The term zero lash used in the procedure refers to the clearance between the slave piston and the exhaust valve adjusting screw.

For P-80 Only: USE CAUTION when adjusting the slave lash, the adjusting screw has a spring loaded piston, exercise caution as the piston in the adjusting screw must be collapsed when final adjustment is performed.

The P-80A has smaller 3/8" thread solid brake adjusting screws.

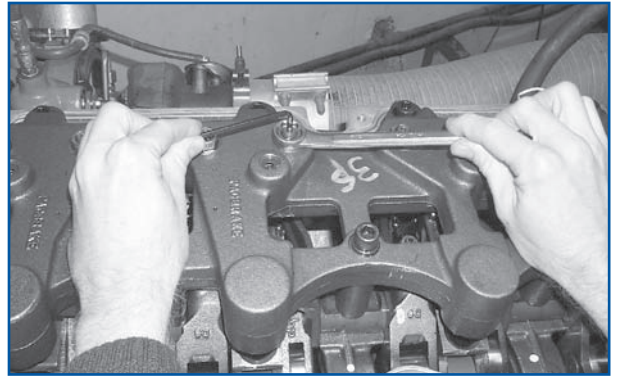

27

From this position (zero lash), turn the Allen wrench counter-clockwise exactly 1/2 turn and torque the locknut to 35 N•m (25 lb. ft.). This method gives the correct slave piston clearance for P-80 of .025" and .032" for P-80A. Repeat this procedure on all cylinders on which the exhaust valves are closed. Bar the engine over approximately one revolution and adjust the remaining cylinders which now have clearance between the exhaust rocker adjusting screw and valve stems. Double check that slave lash has been adjusted on all 12 Pacbrake adjusting screws.

P-80 models use a 1/2" NF thread to achieve a Slave Lash of .025"
P-80A models use a 3/8" NC thread to achieve a Slave Lash of .032"

CAUTION:

Do not overtorque slave adjusting screw locknut.
Double check all torques and wiring prior to reinstalling the valve cover. Use Threebond sealant at front and rear bearing caps at valve cover installation. Torque valve cover bolts as per DDC service manual.

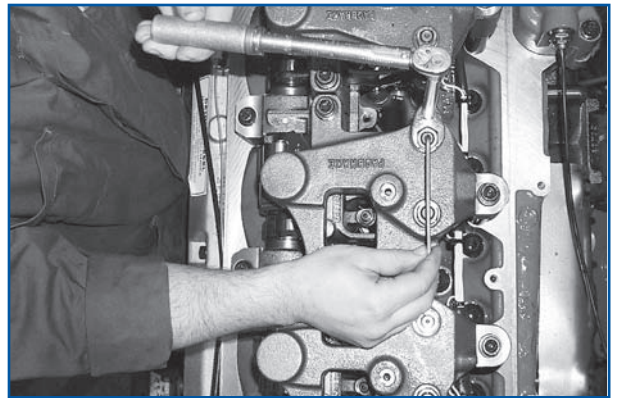

Engines using P60154, follow the instructions provided in the P60154 kit.

28

Control System DDEC IV

ENGINES WITH ENABLE CIRCUIT TURNED ON ONLY
Some DDEC IV engines have the engine brake wiring installed at the factory. If not, follow the instructions below. Locate the 30 pin connector at the rear end of the DDEC IV ECM. This is the Vehicle Interface Harness (VIH).



NOTE: Some DDEC IV engines may not have the ECM programmed for engine braking. This may be verified using a Diagnostic Data Reader. If any of the ECM input switches; K2, K3, S3 or T3 read NONE, then the vehicle should be taken to a DDC dealer to have these switches enabled.

29

Note the color and/or number of the two wires originating at the K2 and K3 terminals of the VIH connector. They are both on the top row, K2 is in the center and K3 is the closest one to the engine.
These two wires terminate behind the dash and may be grouped with a third wire connected to battery ground.



30

Mount the two dash switches and connect the three wires as shown in the DDEC IV wiring schematic.

CAUTION: Ensure that ONLY the negative ground side of the electrical system is input to terminals K2 and K3 via the dash switches OR DAMAGE TO THE ENGINE ECM WILL RESULT.



DDEC IV Wiring Schematic - P-80/P-80A
WITH ENABLE CIRCUIT TURNED ON ONLY

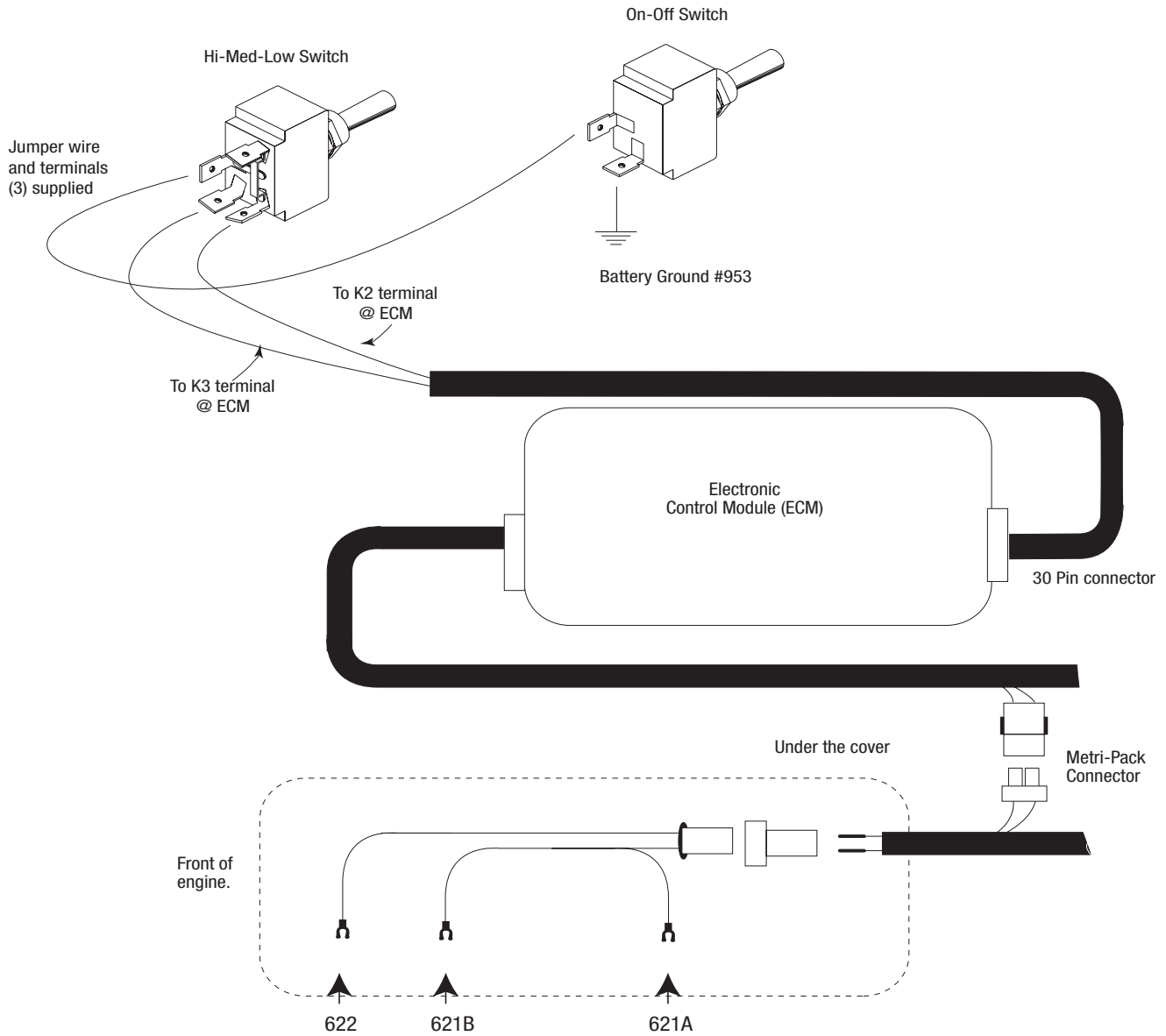

The Metri-Pac connector located above the starter is the same as previous 1999 engines. Orange wire is for the LOW position, red wire is for the MED position, both wires activated for the HIGH position.

NOTES:

- One of the features of the DDEC IV control system provides a progressive brake feature which is used when the vehicle is in cruise control.
- The level of engine brake (low, med., high) selected via the dash switches will be the maximum amount of engine brake the ECM allows.
- Also, using the foot brake or clutch during this procedure disables cruise control and progressive engine brake feature.

Pacbrake Company

toll-free: 800-663-0096

phone: 604-882-0183

fax: 604-882-9278

e-mail: info@pacbrake.com

Internet: www.pacbrake.com

Canada: 19594 96 Ave. Surrey BC V4N 4C3

USA: 250 H St. Box 1822 Blaine WA 98231-1822

Pacbrake exhaust brakes are protected by law.
U.S. patents 5,445,248. Patents pending. Pacbrake and Direct Mount are registered trademarks of Pacbrake Company. Other trademarks used herein are property of their respective holders.
Printed in Canada L2021.220205

PACBRAKE[®]
ENGINE & EXHAUST BRAKES